



UFLUO-HAND

Wireless UV LED detection lamp

Lightness adapted to manual work

More than 5 hours continuous working time

Adapted to most of UV fluorescence and NDT applications.



Electronics	Power supply	Rechargeable Li-ion battery – 18V DC
	Running time	More than 5 hours with a fully charged battery
	Illumination mode	Continuous with an ON/OFF button
Optics	Wavelength	UVC: 275 nm - UVB: 325 nm - UVA: 365, 385, 395, 405 nm - VIS: 465 nm
Mechanics	Width x Length	107mm x 55mm (Head) & 79mm x 110mm (Base with Battery)
	Height	240mm
	Weight	830 g with battery 460g without battery
	Material	Device body: Plastic Head: Aluminum alloy
	IP rating	IP40
Environment	Operation	Temperature: 10°C to 35°C – Humidity: 20% to 80% humidity (with no condensation) – Altitude: Up to 2000m
	Regulations & marking	CE - UKCA
	Environmental standards	RoHS III Directives - REACH Regulation



Product reference

UFLUO-HAND standard version available into a complete KIT for manual use:

KIT - UFLUO - HAND - XXX

WAVELENGTH (nm)

- 275 (UVC)
- 325 (UVB)
- 365
- 385 (UVA)
- 395
- 405
- 465 (BLUE)



UFLUO-HAND PUV version available into a complete KIT according to ASTM E3022-18:

KIT - UFLUO - HAND - 365 - PUV

Wood filter option





Optical considerations

LED spectra

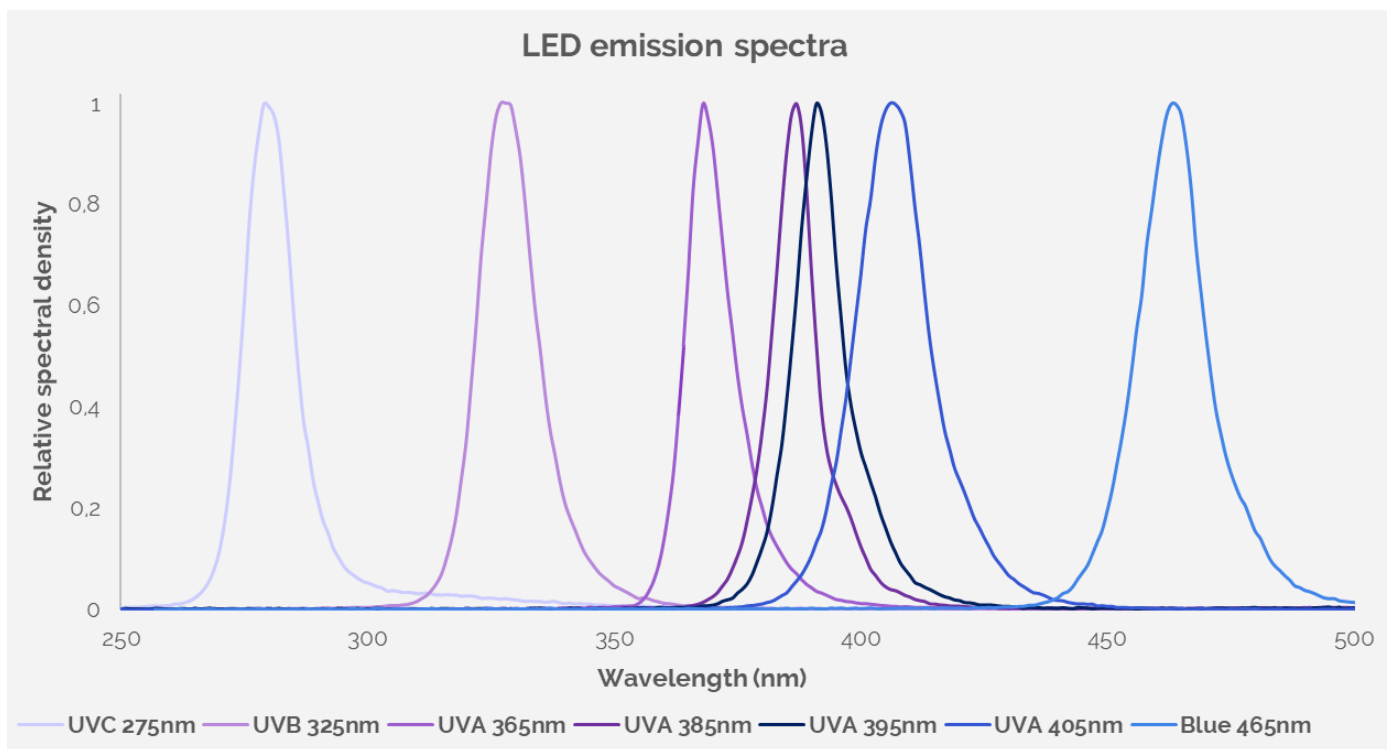

 For other wavelengths (UVC / UVB / UVA / VISIBLE / IR), feel free to ask us!

PUV & Standard versions

For 365nm detection processes, UWAVE offers 2 optical versions:

- UFLUO-HAND-365-PUV is equipped with a Wood filter window to be compliant to ASTM E3022-18 standard for dye penetrant and magnetic particle inspections.
- UFLUO-HAND-XXX is equipped with a transparent PMMA or quartz window to follow ISO 3059:2012 requirements and be adapted for other non-destructive tests.





General Information

UFLUO-HAND-XXX



Mechanical considerations (mm)

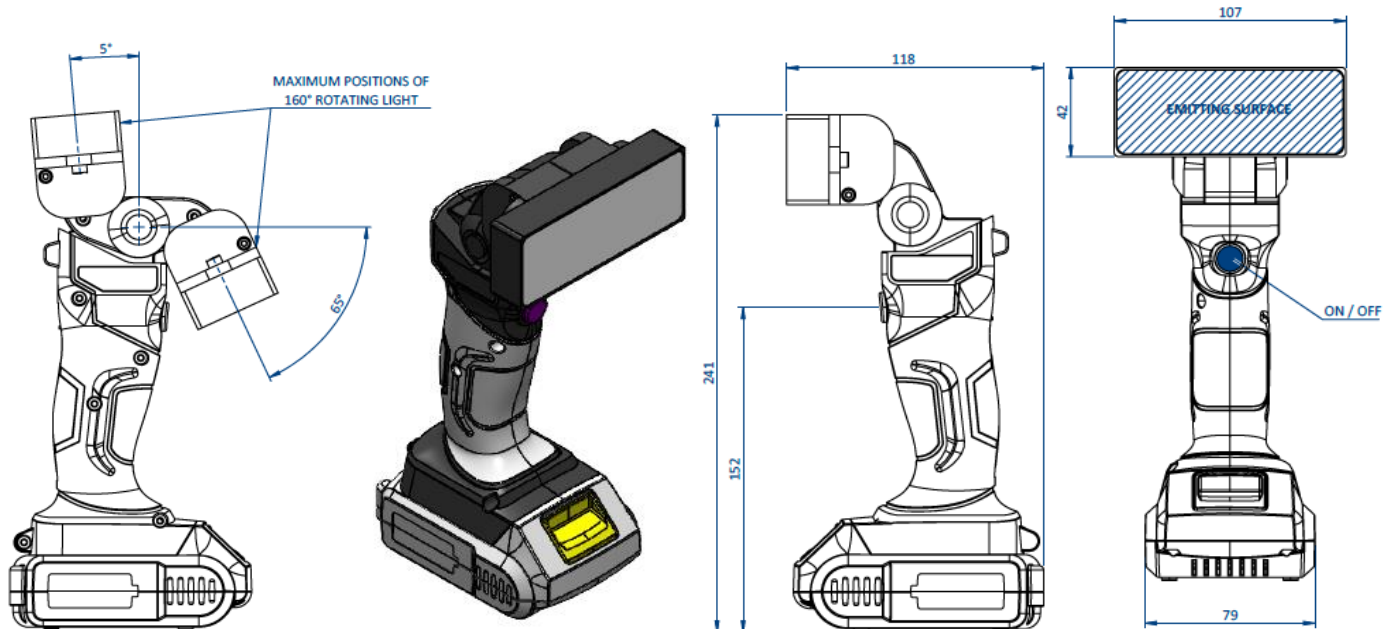



KIT

In order to allow facilitated manual use of the UFLUO-HAND-XXX, UWAVE has developed a complete kit which contains the following components:



ANTI-UV GLASSES
(REF: UGLASS-04)

SUITCASE

UFLUO-HAND-XXX

BATTERY CHARGER

**18 V-1.5 Ah
LI-ION BATTERY**

18V, 1.5Ah Li-ion Rechargeable Battery



The kit contains one 18V rechargeable battery to power the UV LED lighting.

- Each 1.5Ah battery offers a 5-hour continuous running time.
- Full charge of batteries may take up to 45 minutes with the charger.
- Compliant to CE, RoHS, and REACH standards



Battery level is given at the back of the battery with an LED indicator.
With 1 level remaining, battery is low and must be charged.

Batteries Charger



The kit contains a charger to charge the battery.

- The charger is powered with mains cable.
- Full charge of batteries may take up to 45 minutes with the charger.
- LED indicator to see the level of charge (RED charging, GREEN fully charged)
- Compliant to CE, RoHS, and REACH standards



Please fully charge the batteries before first use.











UV security

UWAVE products come under the standard DIN EN 62471:2008 which classified sources of optical radiation into risk groups subject to their potential photo biological hazard. Due to the emission of high UV irradiation, our products belong to Risk Group 3 (hazardous even for momentary exposure) therefore special safety measures, detailed in the following, must be observed.



Thanks to its experience and knowledge about UV risks, UWAVE offers to its customer a wide range of UV protections & services:

Eyes protection	UGLASS-04: To protect eyes from direct rays. 	UGLASS-03: To cover all the face. 	
	Body protection	UGLOVE-01: to protect hands. 	UV-SHIELD: To protect all workers around. 
UV measurement	EIT LEDCURE: UV values recording. 	GIGAHERTZ OPTIK: Direct UV value reading. 	
	UWAVE expertise	EXPOSURE LIMIT VALUE  According to European Directive 2006/25/EC.	PERFORMANCES QUALIFICATION  Monitoring of all performances of your device.