



Before use, please take the time to read this datasheet and make sure you understood the advices and caution of use.



Security of the user

- Do not disassemble or modify the control unit. Doing so may result in fire or electric shock.
- Make sure that the control unit is free of moisture or any liquid. Exposure to water or other liquid may result in fire or electric shock.
- Do not touch the plugs or switches with wet hands. Doing so may result in electric shock.
- Before connecting or disconnecting cables, make sure that the power switch is turned OFF. Failure to do so may result in fire, electric shock, or breakdown in the UV LED lamp. Before moving the control unit, disconnect all cables.
- If an abnormal condition, such as smoking, abnormal heating, abnormal odor, or noise, occurs, stop using the control unit immediately and turn OFF the power switch. Continued use may result in fire or electric shock.
- Do not place the control unit in direct sunlight or in a very humid environment. Doing so may result in fire due to internal temperature rise. Observe the limitations of the operating temperature and humidity.
- Do not install the control unit perpendicularly. Always place the control unit on a stable and flat surface. Not doing so may result in the control unit falling or toppling, which may cause bodily injury or control unit malfunction.
- Do not pile up the control units. Doing so may result in fire due to internal temperature rise.
- Use a cable manufactured by UWAVE to connect the UV LED lamp. Use irradiators that are suitable for the control unit ratings. Doing so may cause control unit failure.
- Please secure a wiring space to the back panel and respect bending radius of cables. Damaging the cables may result in fire or electric shock.

Any incorrect use cancels the warranty.

Table of contents



Security of the user	1
Technical overview	3
Names and functions of parts	4
Quick start	5
ON/OFF MODE	7
TIMER MODE	8
Mechanical dimensions (mm)	9



Technical overview

The UPOWER™ 600W 48V is used to control manually or externally some UWAVE UV LED systems such as:

- UCUBE™
- UBAR™
- UPIN™
- ULINE™ 75
- USTRAIGHT™ 75

<i>Product reference</i>		UPOWER-0600-48
Electronics 	Maximal Power delivered	600 W
	Input power	Single phase 85 to 264 VAC, 50/60 Hz
	Connector to 220V	IEC C14
	Output voltage and current	48 VDC and 12.5 A for one Channel
	Connectors to UV products	SUBD13W3
	Inrush current (typ.)	35 A at 115 VAC and 70 A at 230 VAC
	Ground leakage current	1.2 mA max at 240 VAC
Mechanics 	W*L*H (mm)	250mm * 410mm * 120mm
	Weight	7 kg
	Material	Device body: Aluminum alloy
Environment 	Working temperature	+10°C to +35°C
	Working Humidity	< 80% for temp < 30°C
	IP Code	IP20
Accessories		Key x1 pc., M12 "Schunt" connector x2 pcs., 2.5m power cable x1 pc and instruction guide x1 pc.



Names and functions of parts

Front side (UPOWER-FAV-0600-TIMER):

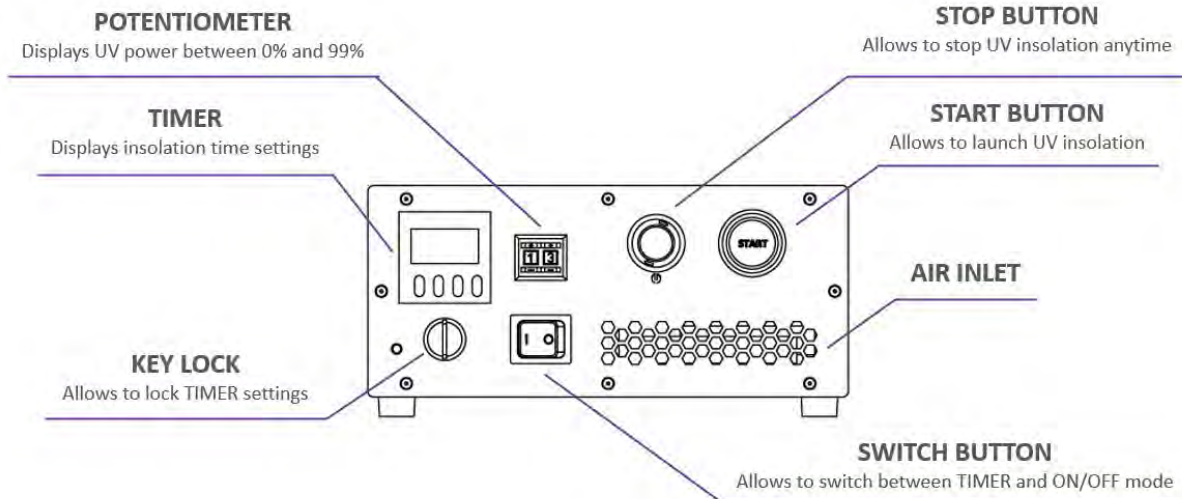

Rear side (UPOWER-FAR-0600-TIMER):

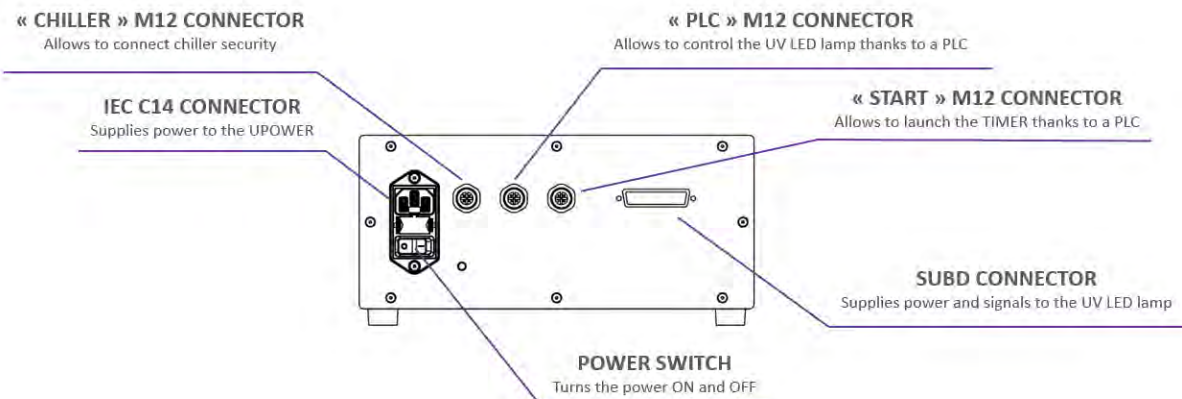



Quick start

1. Installation requirements:

- Place the control unit on a stable and flat location.
- Provide sufficient space around the control unit so that the ventilation holes are not blocked. Minimum 100mm at the front and back panel and minimum 50mm at lateral panels.
- Make sure that the airflow does not cause the exhausted warm air to be drawn into the control unit again.

2. Connect the female side of the SUBD13W3 cable to the UV LED lamp and the male side to the control unit. Please, notice that for an optimal connection, both sides of the cable must be screwed.

3. The M12 5 pins connector on the rear side named "CHILLER" is a security for water cooled UV LED lamps. The control unit waits for a signal from the chiller in order to allow UV light emission. **If this step is not realized, the UV LED lamp will not switch on.**

- Plug the water pipes from the chiller to the UV LED lamp and the M12 5 pins cable from the chiller to the control unit.
 - ➔ Please refer to the "chiller notice" for more information.
- If you do not use a chiller with your UV LED lamp, plug the M12 5 pins connector named "Schunt".
- If you use your own chiller, please refer to the electrical scheme below to install a chiller security.

Pin number	Color	Type	Function	
1	Brown	out	+ 24 VDC	
2	White	Out	0V – GND	
3	Blue	In	0 VDC	Security activated
			24 VDC	Security not activated
4	Black	-	Not used	
5	Blue	-	Not used	

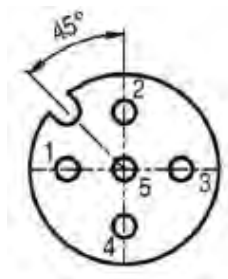

M12 connector scheme on the left and "Schunt" picture on the right

4. The M12 5 pins connector on the rear side named “PLC” allows a PLC analogue communication. The control unit waits for a signal in order to allow UV light emission. **If this step is not realized, the UV LED lamp will not switch on.**
- If you are using manually the control unit, plug the M12 connector named “Schunt”.
 - Otherwise, please refer to the electrical scheme below to install an external communication (PLC).

Pin number	Color	Type	Function	
1	Brown	out	+ 24 VDC	
2	White	Out	0V – GND	
3	Blue	In	0 VDC	UV emission not allowed
			24 VDC	UV emission allowed
4	Black	-	Not used	
5	Blue	-	Not used	

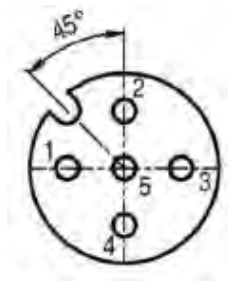

M12 connector scheme on the left and “Schunt” picture on the right

5. Connect the power cable into the IEC C14 connector and into the wall. Then, the power switch can be turned on.
6. The user can adjust the UV light intensity from 20% to 99% of maximal power thanks to the potentiometer (digits appear 20 to 99).
7. The UV LED lamp is now ready to be used. Two operating modes are available:
- ON/OFF mode
 - TIMER mode
- ➔ You can switch between these two modes thanks to the switch button on the front side.

**ON/OFF MODE**

The ON/OFF mode allows the user to control the activation and the deactivation of the UV light emission manually thanks to the potentiometer, the START button, and the STOP button on the front panel. It also allows the user to control the UV LED lamp thanks to a PLC.

1. Manually:

- **Verify that the two “schunt” connectors are plugged on “chiller” and “PLC” M12 5pins connectors at the back panel.**
- **Choose the UV light intensity between 20% and 99% thanks to the potentiometer.**
- **Launch UV light emission by pushing the START button and press START again to stop it.**
- **Press STOP to switch off the light in case of an emergency. When this button is engaged, you must disengage it to allow UV light emission.**

2. With a PLC:

- **Verify that the “chiller” security is not activated (water circulation) or use a “schunt” connector on the “chiller” M12 5 pins connector at the back panel.**
- **Choose the UV light intensity between 20% and 99% thanks to the potentiometer.**
- **Press START to allow future UV light emission.**
- **The PLC can switch on or off UV light emission thanks to the dry contact between pin1 and pin3 on the “PLC” M12 connector at the back panel (please refer to the electrical scheme of page 6).**
- **Press STOP to switch off the light in case of an emergency. When this button is engaged, you must disengage it to allow UV light emission.**



TIMER MODE

The TIMER mode allows the user to choose the UV light emission time manually thanks to the TIMER located on the front panel. TIMER parameters can be locked thanks to the key. In the standard version, the time can be adjusted between 1 second and 99 minutes 99 seconds. For other time range, feel free to contact us. It also allows the user to control the UV LED lamp thanks to a PLC.

1. Manually:

- Verify that the two “schunt” connectors are plugged on “chiller” and “PLC” M12 5pins connectors at the back panel.
- Choose the UV light intensity between 20% and 99% thanks to the potentiometer.
- Adjust the insolation time thanks to the arrows on the TIMER (orange display). Push the “RESET” button to validate the insolation time. Then, the time is displayed in red above the orange display.
- Launch UV light emission by pushing the START button. Then, the time is elapsing (red display). When the insolation time is finished, the UV light emission stops.
- Press STOP to switch off the light in case of an emergency. When this button is engaged, you must disengage it to allow UV light emission.

2. With a PLC:

- Verify that the “chiller” security is not activated (water circulation) or use a “schunt” connector on the “chiller” M12 5 pins connector at the back panel.
- Choose the UV light intensity between 20% and 99% thanks to the potentiometer.
- Adjust the insolation time thanks to the arrows on the TIMER (orange display). Push the “RESET” button to validate the insolation time. Then, the time is displayed in red above the orange display.
- The PLC can allow UV light emission thanks to the dry contact between pin1 and pin3 on the “PLC” M12 connector at the back panel (please refer to the electrical scheme of page 6).
- The user can use the “START” M12 5 pins connector at the back panel to launch the TIMER externally (PLC or footswitch). Then, the time is elapsing (red display). When the insolation time is finished, the UV light emission stops. Please refer to the electrical scheme below:

Pin number	Color	Type	Function
1	Brown	-	START +
2	White	-	Not used
3	Blue	-	START -
4	Black	-	Not used
5	Blue	-	Not used

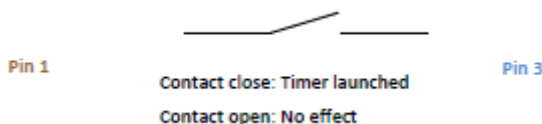

- Press STOP to switch off the light in case of an emergency. When this button is engaged, you must disengage it to allow UV light emission.



Mechanical dimensions (mm)

